

Comply and compatible with 19 inch international standard, metric system & ETSI standard. Welded structure, stable, static loading capacity 60 kg.

**Product Description**

Product Type	Double Door Wallmount Rack
Product ID	WIR5510D
Size	10U
Weight	± 28 kg
Dimension (DxWxH)	550 x 600 x 545 mm
Complete Set with	<ul style="list-style-type: none"> <li>• Glass Front Door and 2 Side Door with lock</li> <li>• 1 Unit Horizontal PDU 6 outlet with switch</li> <li>• 1 Unit Single Fan 220VAC</li> <li>• 1 pc Top Brush Panel</li> <li>• 4 pcs Dynabolt 88mm</li> <li>• 20 set M06 (Cagenuts &amp; Screws)</li> </ul>



**Product Drawing**

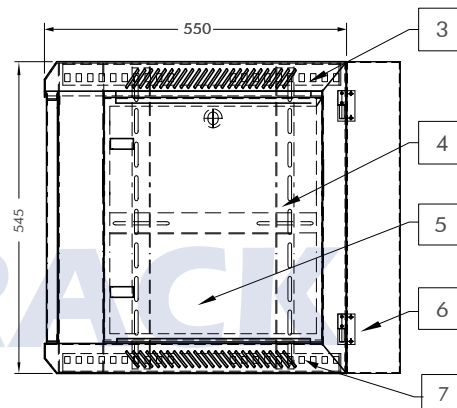
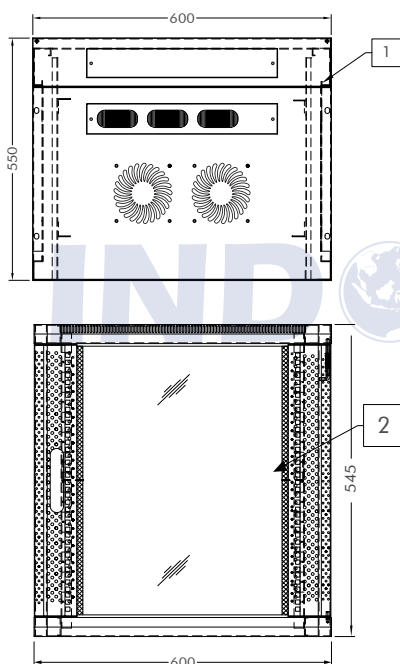

1. Frame
2. Front Door
3. Top, Bottom, Back Panel
4. Mounting Angle
5. Side Door
6. Rear Door
7. Mounting Profile



- A** Removable Side Door
- B** L Tower Bolt Lock Side Door
- C** L Tower Bolt Lock Inside

Quick and easy wall mounted 19 inch standard installation inside. Open angle for front and side door is over 180 degrees. Removable lockable side door, with L tower bolt lock side door and inside, cable entry from top and bottom.

Product Drawing

